



# Datasheet

## LED Tri-proof Light

P Version: Multiple functional endcap



### • Product Features

- > Quick-snap end-caps for easy installation
- > Single or Double wiring
- > IP 65 / IK10 Approval
- > Multiple Link with double wiring
- > Patent aluminum case as heatsink
- > 5 years warranty

### • Options

- >Wiring: Single or Double
- > CRI : Ra>80 or Ra>90
- > Function : ON-OFF / 1-10V dimming / MS / DALI
- > Lumen Efficacy : 100LM/W , 125LM/W ,140LM/W

### • Application

- > Replacement for fluorescent NCF ,
- > Warehouses , Factories, Car parks , Sports facilities,
- > Sports facilities, Outdoor & Indoor Locations.

### • Dimension



Product Name	A	B	C
2ft/60cm	600	83.8	72.8
4ft/120cm	1200	83.8	72.8
5ft/150cm	1500	83.8	72.8

Unit:mm

### • Product Picture



### • Explosion drawing

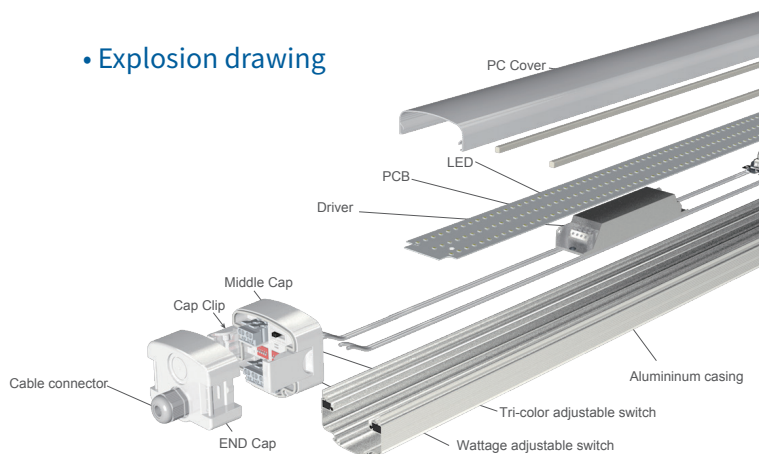

### • Product code policy

**TR XX -XX X XX - X X X X X- XXX**

01 02 03 04 05 06 07 08 09 10 11

01. Product category: TR: Tri-proof Light
02. Product dimension: eg: 04:4ft/120CM; 06:6ft/180cm
03. Rated power: eg: 30: 30W; 40: 40W
04. Luminous Efficacy: S: Standard 100LM/W;P:Premium 125LM/W
05. Color Temperature: eg:N1: 4000~4500K, TR:Tri-color
06. Product version: P: P version tri-proof light
07. Structural function: F:Frosted cover
08. Electrical function:N:ON/OFF
- 09.Power attribute:1:AC200-240V Flicker free power drive
- 10.Power supply manufacturer
- 11.Series No.: 001-499.

### • Photometry Curve

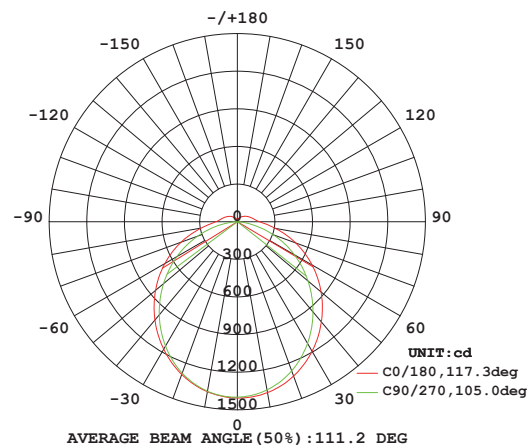

### • Technical / Electrical Characters (at TA=25°C)

Item	Symbol	L=600/2ft			L=1200/4ft			L=1200/4ft			L=1500/5ft		
		Standard	Premium	Deluxe	Standard	Premium	Deluxe	Standard	Premium	Deluxe	Standard	Premium	Deluxe
Rated Power	W	12~30W adjustable			22~40W adjustable			32~64W adjustable			32~64W adjustable		
Product Code	/	TR02-30STR -PFN1B-200	TR02-30PTR -PFN1B-200	TR02-30DTR -PFN1B-200	TR04-40STR -PFN1B-200	TR04-40PTR -PFN1B-200	TR04-40DTR -PFN1B-002	TR04-64STR -PFN1B-200	TR04-64PTR -PFN1B-200	TR04-64DTR -PFN1B-200	TR05-64STR -PFN1B-200	TR05-64PTR -PFN1B-200	TR05-64DTR -PFN1B-200
LED Type /Qty	SMD2835	143pcs	143pcs	143pcs	234pcs	234pcs	234pcs	325pcs	325pcs	325pcs	325pcs	325pcs	325pcs
Lumen Efficacy	Lm/w	typ.100	typ.125	typ.140	typ.100	typ.125	typ.140	typ.100	typ.125	typ.140	typ.100	typ.125	typ.140
Luminous Flux	Frosted	Max 3000LM	Max 3750LM	Max 4200LM	Max 4000LM	Max 5000LM	Max 5600LM	Max 6400LM	Max 8000LM	Max 8960LM	Max 6400LM	Max 8000LM	Max 8960LM
Color Index	CRI (Ra)	Ra>80 OR Ra >90											
Color Temperature	TC (K)	Tri-color:3000K~5000K,Mixed 4000K											
Beam Angle	Degree	120 degree											
LED current	mA	Constant 50mA											
Input Voltage	V	AC200-240V/50Hz											
Working Voltage	V	Constant DC36-42V											
Housing material	/	Aluminum +PC											
Protection Class	IP	IP65/ IK10											
Temperature	°C	Operation : -15°C~+50°C Storage: -25°C~+55°C											
Life Span	h	50,000 hours											
Switching Cycle before Failure	/	>100,000 times											
Warranty	/	5 years											

### • ErP Technical Specification

Item	Symbol	Specification / Data
Power factor	PF	>0.95
Efficiency in	%	>93%
Energy efficiency Class	/	A++
Standard deviation of color matching	/	<5
Starting Time	S	<0.5S
Warm-up time to 60%	S	<0.5S
Rated nominal Lifetime	/	>50,000 hours
Driver MTBF	/ /	200,000 hours.MIL-HDBK-217F(25°C)
Lumen Maintenance at e.o.l.	%	>70%
LED Device Lifetime	/	L80/B10@50,000 hours



### • Wiring Method

1). Single side power input wiring



2). Double side power input wiring



3). The cover must be locked to ensure IP65 waterproof performance

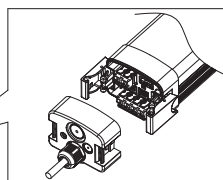

### • Install Caution

1). the maximum connection number based on the product power please follow to the product label information to connect

2). Please make sure the end cap and waterproof connector be locked after wiring connection

3). Specification of the connected cable

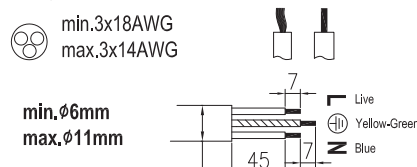

## • Installation Instructions

### 1. Surface mounting procedure:

1). Fix the supplied metal clips onto a mounting surface as per the installation below

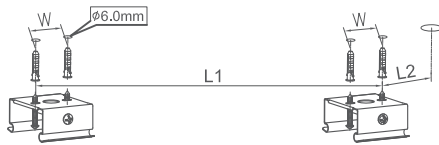

Product Size	Size W	Size L1	Size L2
600*83.8*72.8mm	35mm	300mm	200mm
1200*83.8*72.8mm	35mm	900mm	200mm
1500*83.8*72.8mm	35mm	1200mm	200mm
2400*83.8*72.8mm	35mm	1150mm	200mm

2). Push the Lamp body into the mounting clips

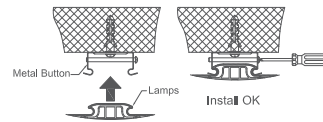
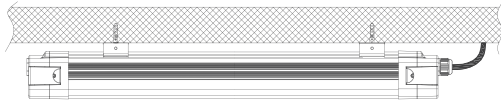

### 2. Suspending Procedure:

1). Install the suspension rope then wiring as below instructions

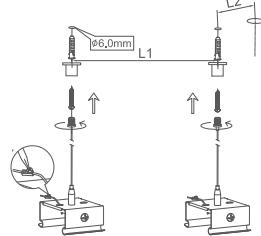

2). Adjust the length of the suspension rope to reach the suitable height and push the Lamp body into the mounting clips

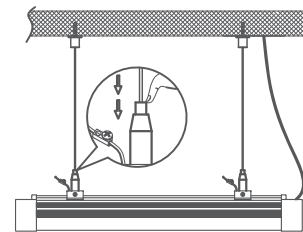

### 3. Wiring steps and requirements

- 1). Open the End cap
- 2). Open the waterproof connector and access the protective cable, wiring diagram as shown on the right and tighten the waterproof connector

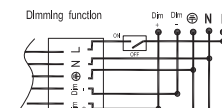
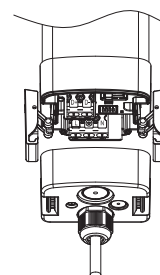
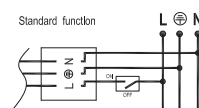
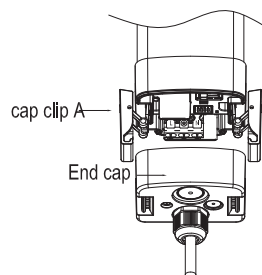

## • Package

Product Type	Rated Power	Inner Box	Outer Carton	Qty/Carton	Unit N.W	G.W/Carton
60cm/2ft	12~30W	700 x 92 x 82mm	720 x 190 x 215mm	4Pcs	1335g	7.8Kg
120cm/4ft	22~40W/32~64W	1300 x 92 x 82mm	1320 x 190 x 215mm	4Pcs	2355g	12.5Kg
150cm/5ft	32~64W	1600 x 92 x 82mm	1620 x 190 x 215mm	4Pcs	3100g	15.5Kg

## ! CAUTION

- ※ In case of electric shock, please make sure the power is off before installation.
- ※ The lamp should be installed and operated by a qualified electrician or technician in accordance with relevant local codes.
- ※ Do not use sharp tools near or on the surface of the lamp.
- ※ Unpack and examine the product carefully. Report any damage and save all packing materials if any portion of the product was damaged during transportation.